

HISENKO

HISENKO  
TOP IDEAS FOR LIFE



# COMPANY About us INTRODUCTION

ZHEJIANG HISENKO HVAC CO.,LTD. located in TAIZHOU, a famous Economic City, Who is a professional manufacturer.

Now our products including brass ball valve,brass fitting, temperature control valve, radiator accessories as well as heating instruments ect. which export to many market, Included Europe, America, Africa, Aisa and Middle East ect.

After more then ten years development,we have completely followed its program.has rich technical power, superior processing equipment ,advanced production technic, high precision testing means and perfect management.On the basis of " Quality First,Service Foremost,price best." In order to develop high-quality products, we establish a strong R&D team, and technical stuff near 20 , we hope to find the agent in most country and establish the global sales channels, which enable Hisenko's products very famous in the world, as the OEM factory,though we have ourself brand LD and HS, we also can supply many kinds products to our partner with their brand and their design.

We are not the biggest factory but skilled workers and technicians are engaged with us to produce the best quality of all products according to the International standardization ISO9001 and CE Mark.

Our trademark is "100% Customer Satisfaction". At present many foreign traders have contracted us as manufacturer and our products are distributed worldwide. Our dedication to constantly improving quality is the best assurance to customers.

Now we are planning spread our distribution network further by opening more branches and find more agent in the world to closer to our clients. Welcome everyone who are interested in us.Give us a try! We believe we will stronger together.

## Introducing Hisenko HVAC Solutions - Pioneering Smart Control for Comfort and Efficiency

Welcome to Hisenko HVAC Solutions, a cutting-edge innovator and provider of intelligent control systems for heating, ventilation, air conditioning, and automation (HVAC) since 2018. At the core of our enterprise lies a profound dedication to enhancing the way buildings use and manage their environmental conditions through smart, integrated solutions.

### Our Vision in Motion:

Hisenko HVAC Solutions has been architecting advanced intelligent control systems that merge the latest technology with user-friendly interfaces. Our mission is to optimize the performance of HVAC systems worldwide, resulting in energy savings, improved comfort, and enhanced air quality for both residential and commercial clients.

### Innovative Product Suite:

Our comprehensive range of intelligent control products features state-of-the-art technologies including:

1. Smart Thermostats: With autonomous learning capabilities, our smart thermostats adapt to your lifestyle, reducing energy consumption without compromising on comfort.
2. Building Management Systems (BMS): We offer tailored BMS solutions that allow facility managers to monitor and control every aspect of a building's HVAC operations from a single platform.
3. IoT Enabled Controllers: Our Internet of Things (IoT) enabled controllers provide real-time data analytics, enabling predictive maintenance and remote troubleshooting.
4. Sensors and Meters: Highly accurate sensors and meters form the backbone of our intelligent control systems, ensuring precise measurements and responsive adjustments.
5. Occupancy Detectors: Our occupancy detectors ensure HVAC systems operate efficiently based on actual occupancy rates, conserving energy when rooms are unoccupied.

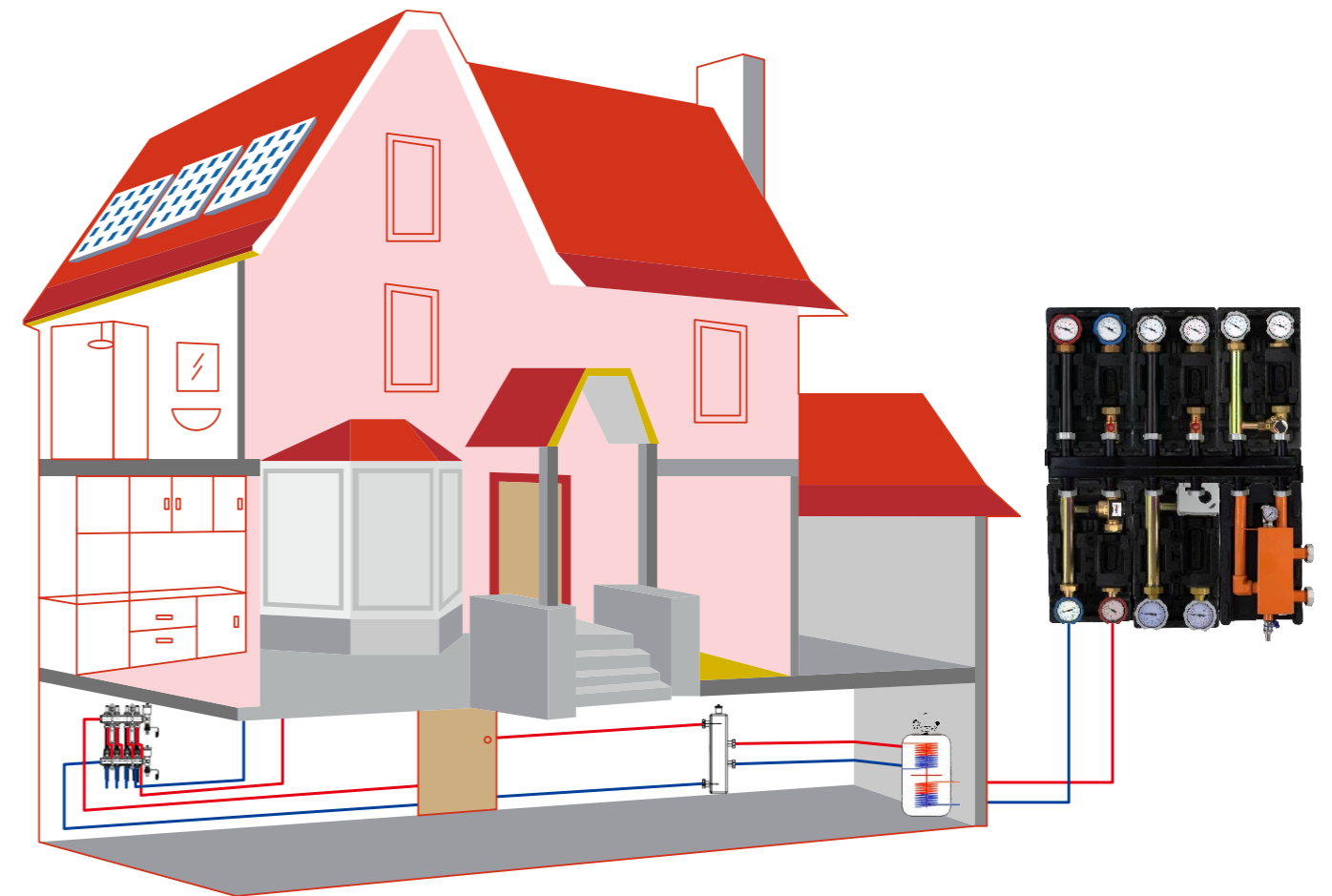

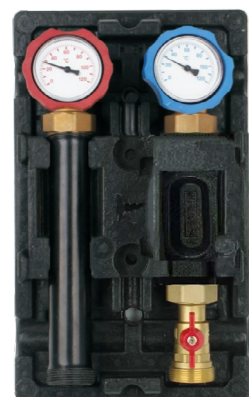

**Item No:8100**  
Direct Circulation unit



**Item No:8102**  
Mixing valve Circulation unit



**Item No:8104**  
Mixing valve Circulation unit



**Item No:8101**  
Direct Circulation unit



**Item No:8103**  
Thermostatic Circulation unit



**Item No:8105**  
Hydraulic neutralizer

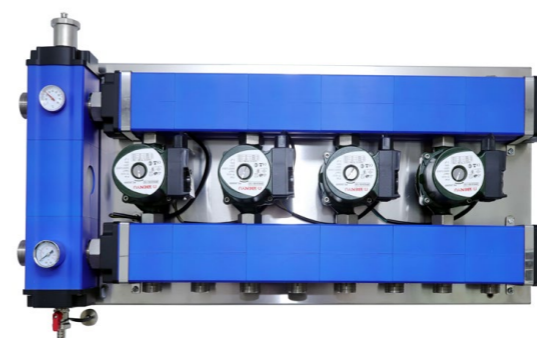

**Item No:8111**

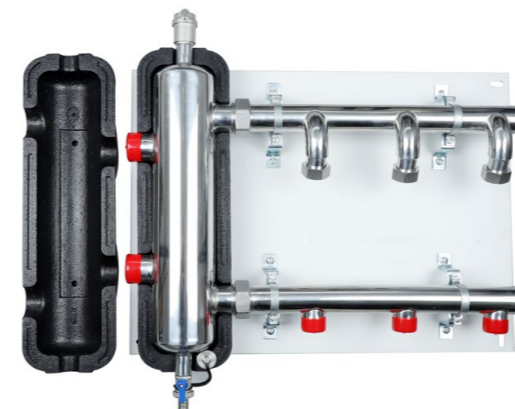

**Item No:8113**



**Item No:8115**



**Item No:8112**



**Item No:8114**

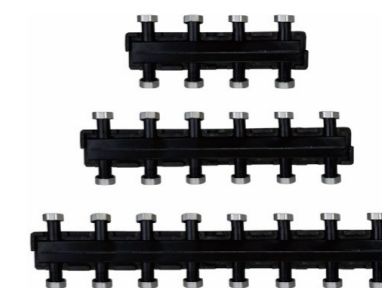

**Item No:8106**

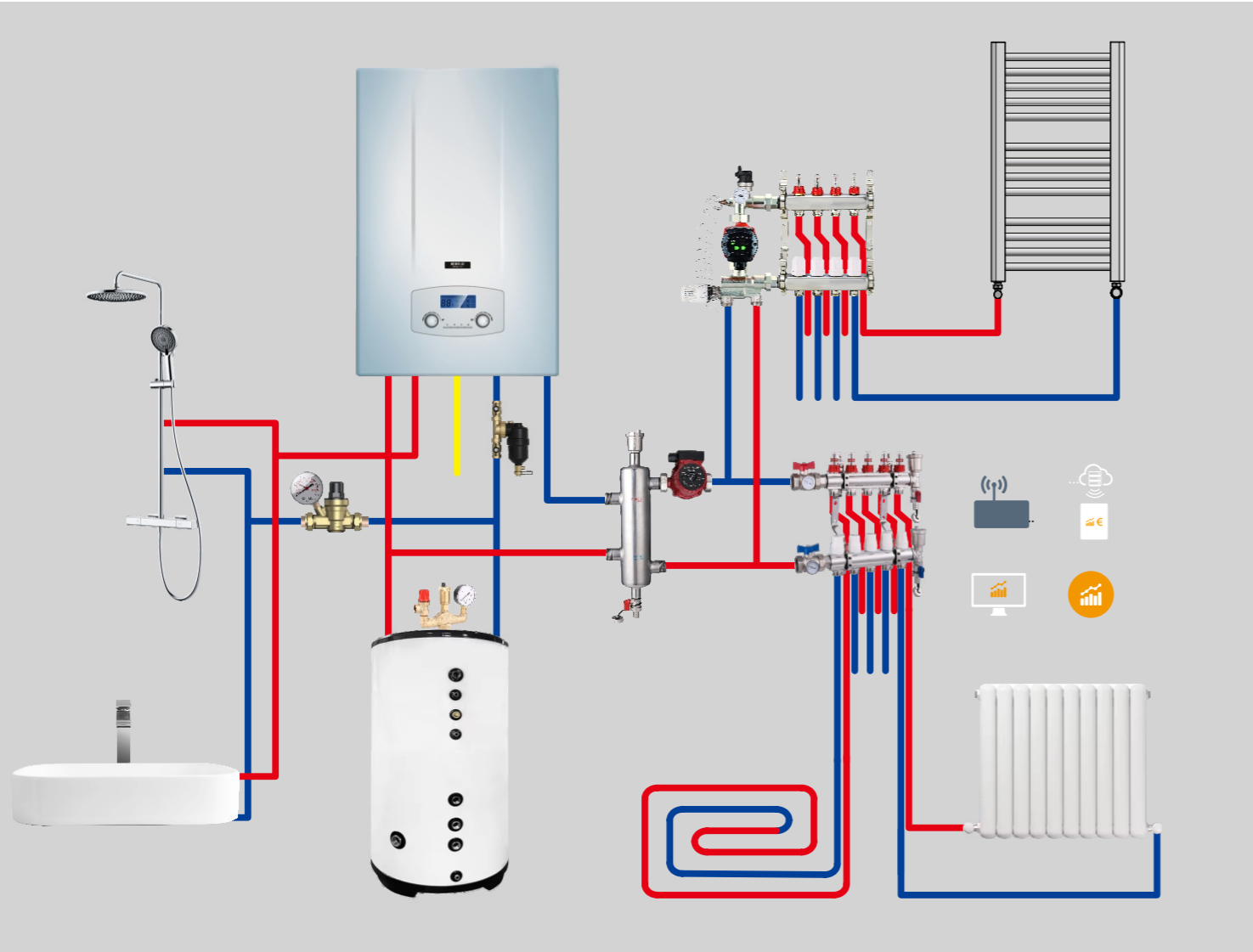

**Dedication to Excellence:**

At Hisenko HVAC Solutions, we place a strong emphasis on quality and continuous improvement. Our stringent quality assurance protocols and adherence to global standards guarantee that each product we manufacture meets the highest industry benchmarks.

**Investing in Tomorrow's Technology:**

We pride ourselves on our research and development team that is consistently at the forefront of innovation. Their relentless pursuit of advancement has led to breakthroughs in AI-driven controls, wireless communication, and energy-efficient algorithms.

**Global Presence, Local Impact:**

With a far-reaching distribution network and partners across continents, Hisenko HVAC Solutions delivers its sophisticated systems to customers worldwide. Despite our expansive reach, we maintain a commitment to localized service, offering personalized support in multiple languages and time zones.

**Sustainability: Our Responsibility:**

We recognize our role in protecting the environment and have integrated sustainability into every facet of our operations. From eco-friendly offices to power-efficient products, our initiatives aim to minimize our carbon footprint while empowering our customers to do the same.

**Customer-Centricity at Its Best:**

For us, customer satisfaction isn't just a metric—it's a guiding principle. We listen to our customers' needs, engage with their feedback, and strive to deliver intelligent solutions that exceed expectations, simplify operations, and add value to their businesses.

**The Road Ahead:**

As we move forward, Hisenko HVAC Solutions remains steadfast in its quest to revolutionize the way buildings interact with their HVAC environments. Our pipeline is filled with groundbreaking projects like cloud-based management systems and voice-activated controls, setting new standards for intelligence and convenience.

At Hisenko HVAC Solutions, we are more than just creators of intelligent control systems—we are your partner in realizing efficient, comfortable, and smart living environments. Join us in unlocking the full potential of your HVAC systems.



Item No:8210



Item No:8211



Item No:8212



Item No:8216



Item No:8218



Item No:8219



Item No:8215



Item No:8217



Item No:8310



Item No:8313



Item No:8231

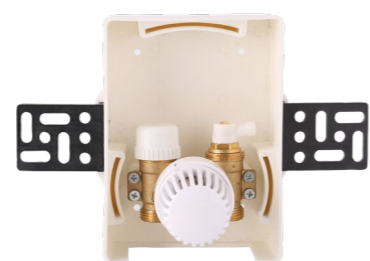

Item No:8232



Item No:8311



Item No:8314



Item No:8233



Item No:8234



Item No:8312



Item No:8315

- ★ Cartridge can be exchangeable and Optional
- ★ Handle can be optional

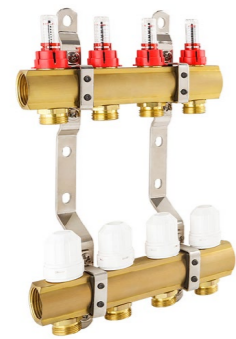
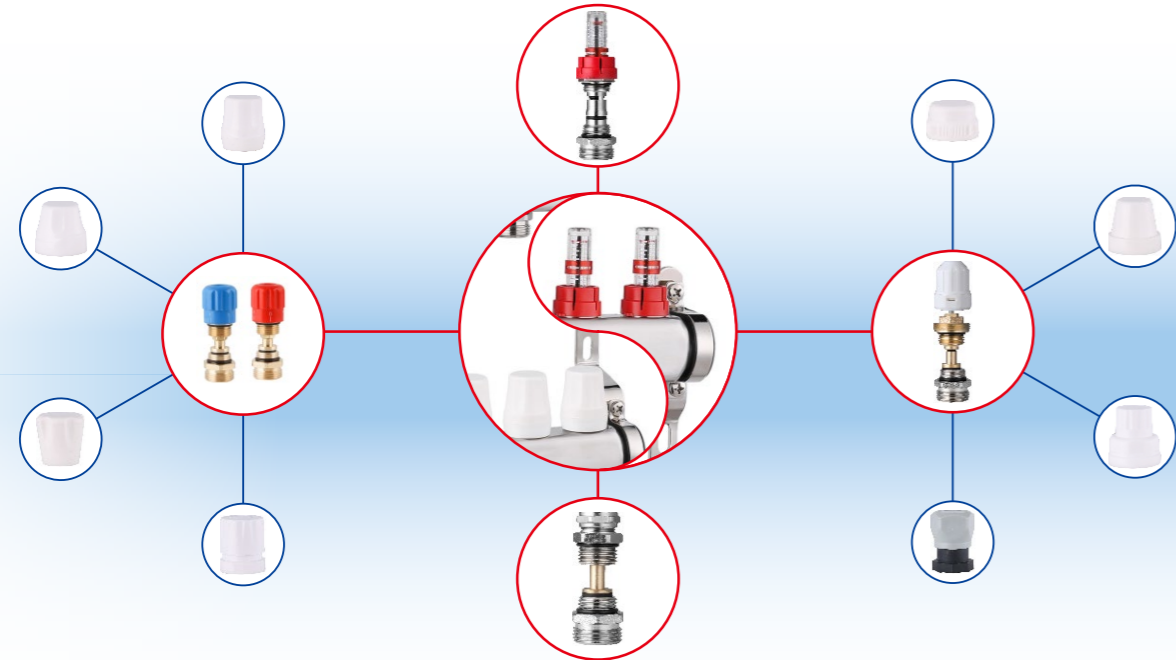

**Item No:8410**



**Item No:8430**

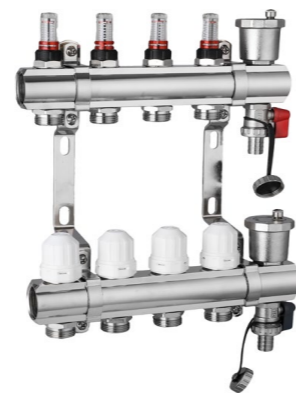

**Item No:8455**

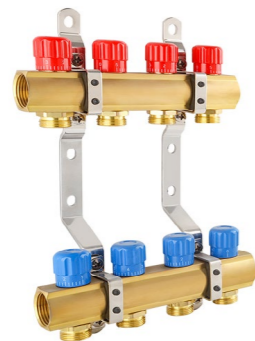

**Item No:8420**



**Item No:8445**

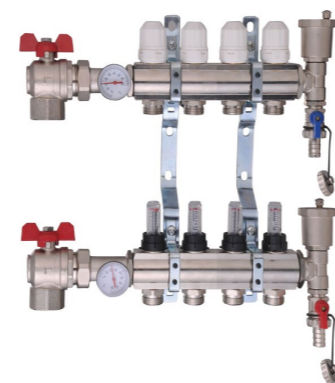

**Item No:8459**



**Item No:8460**



**Item No:8470**

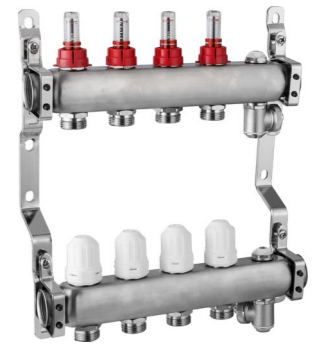

**Item No:8485**



**Item No:8490**



**Item No:8491**



**Item No:8494**



**Item No:8492**



**Item No:8493**



**Item No:8495**



**Item No:8500**



**Item No:8503**



**Item No:8504**



Item No:8610



Item No:8614



Item No:8621



Item No:8821



Item No:8822



Item No:8663



Item No:8611



Item No:8615



Item No:8622



Item No:8625



Item No:8626



Item No:8653



Item No:8612



Item No:8623



Item No:8625



Item No:8652



Item No:8662



Item No:8655



Item No:8613



Item No:8641



Item No:8624



Item No:8656



Item No:8644



Item No:8642



Item No:8682



Item No:8687



Item No:8688



Item No:8689



Item No:8700



Item No:8701



Item No:8702



Item No:8703



Item No:8683



Item No:8684



Item No:8685



Item No:8686



Item No:8841



Item No:8842



Item No:8843



Item No:8844



Item No:8690



Item No:8711



Item No:8716



Item No:8831



Item No:8835



Item No:8691



Item No:8712



Item No:8717



Item No:8832



Item No:8836



Item No:8692



Item No:8713



Item No:8718



Item No:8833



Item No:8837



Item No:8693



Item No:8715



Item No:8719



Item No:8834



Item No:8839





Item No:8731



Item No:8735



Item No:8739



Item No:8751



Item No:8747



Item No:8771



Item No:8732



Item No:8736



Item No:8740



Item No:8752



Item No:8748



Item No:8772



Item No:8733



Item No:8737



Item No:8741



Item No:8753



Item No:8743



Item No:8773



Item No:8734



Item No:8738

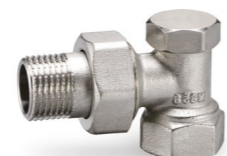

Item No:8742



Item No:8754



Item No:8744



Item No:8774



**Item No:8781**



**Item No:8786**



**Item No:8797**



**Item No:8782**



**Item No:8791**



**Item No:8798**



**Item No:8783**



**Item No:8793**



**Item No:8800**



**Item No:8784**



**Item No:8796**



**Item No:8801**

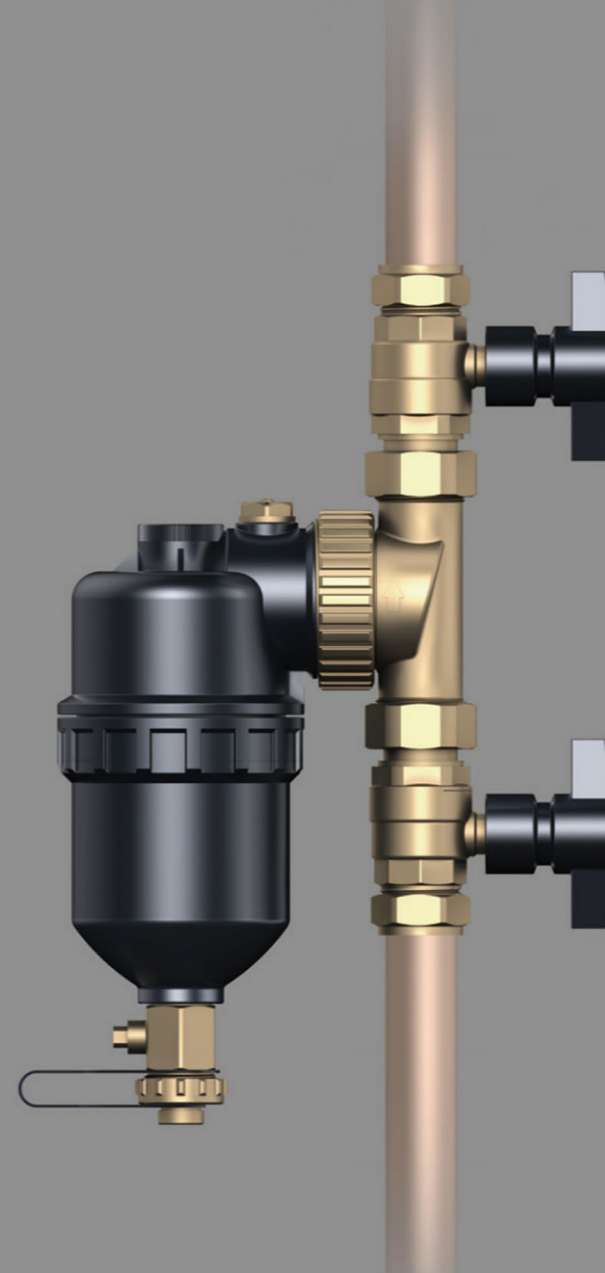

**Features & Benefits**

Works as a dual filter to maximise the life expectancy of your whilst maintaining fuel efficiency

- Compact design for easy installation and maintenance
- Removes magnetic and non-magnetic particles
- Removes Iron, Nickel and Cobalt particles in the water
- 22&28mm compression fittings
- Glass filled reinforced plastic nylon
- Maximum working temperature 120 Deg C
- Maximum working pressure 5 bare
- Maximum flow rate 50 litre per min
- Rare neodymium 12,000 gauss magnet
- All the seals are high temperature EPDM sealse
- Saves energy by up to 6% per annum
- Provides consistent protection for the boiler system
- Extends the lifetime of the system
- Reduces carbon emissions
- Saves maintenance cost

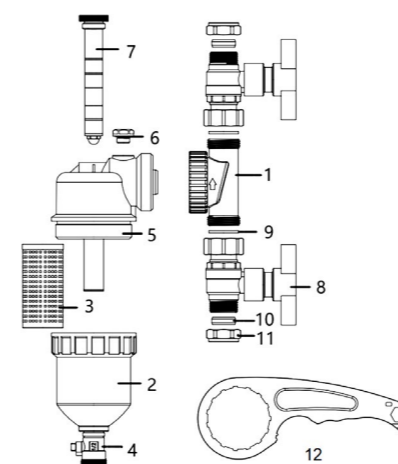

**Item No:8661**

Item	Qty	Component	Item	Qty	Component
1	1	Connector block	7	1	Removeable magnet
2	1	Filter pot	8	2	Ball valve
3	1	Filter	9	2	Ball valve seal
4	1	Drain valve	10	2	Olive
5	1	Screw cap	11	2	Compression nut
6	1	Air vent	12	1	Spanner



Item No:8657



Item No:8671



Item No:8765



Item No:8860



Item No:8864



Item No:8675



Item No:8851



Item No:8660



Item No:8672



Item No:8766



Item No:8861



Item No:8865



Item No:8877



Item No:8852



Item No:8658



Item No:8673

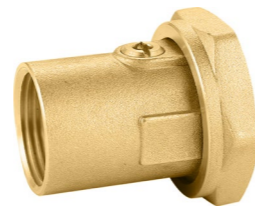

Item No:8823



Item No:8862



Item No:8866

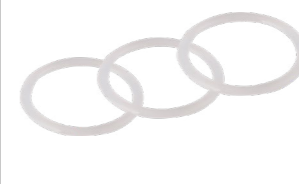

Item No:8876



Item No:8853



Item No:8659



Item No:8825



Item No:8824



Item No:8863



Item No:8867



Item No:8875



Item No:8874

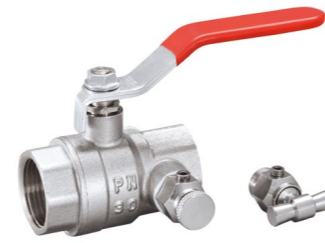
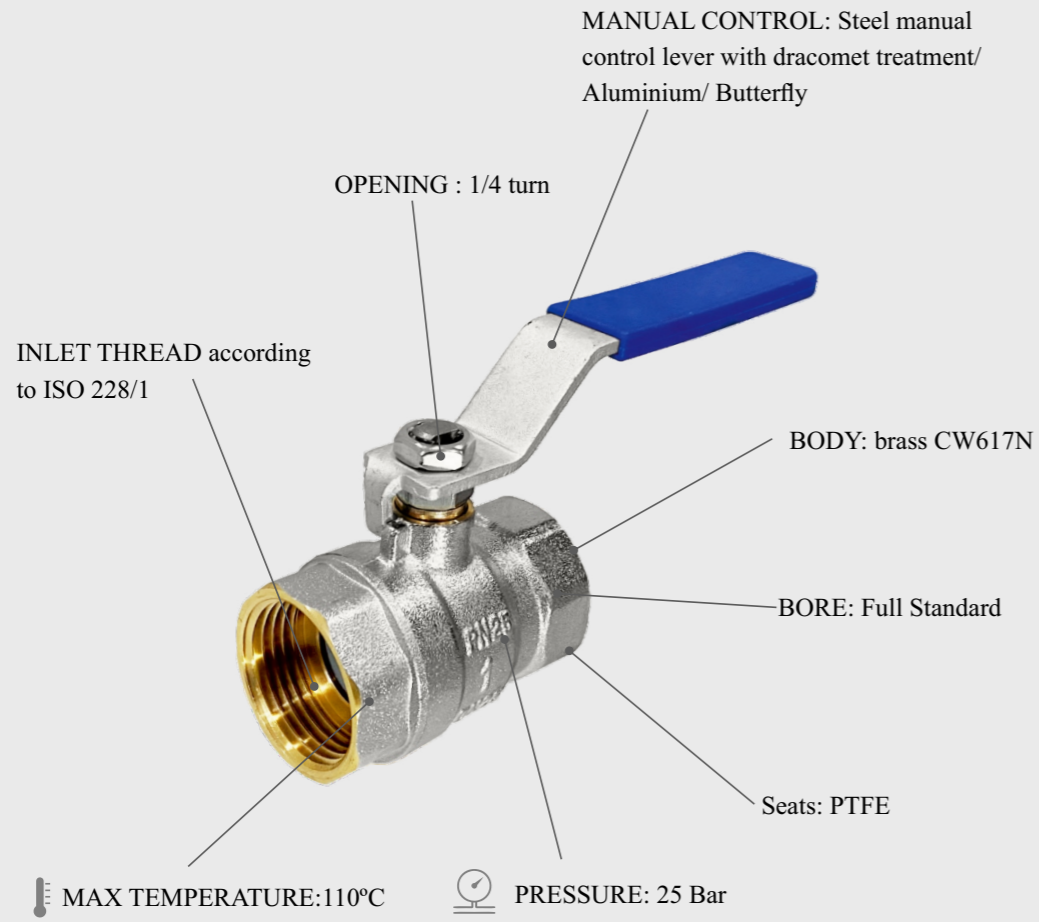

Item No:5009



Item No:5034



Item No:5021



Item No:5031



Item No:5035



Item No:5022



Item No:5001



Item No:5004



Item No:5007



Item No:5032



Item No:5036



Item No:5024



Item No:5002



Item No:5005



Item No:50008



Item No:5033



Item No:5037



Item No:5025



Item No:5321



Item No:5041



Item No:5044



Item No:5101



Item No:5106



Item No:5103



Item No:5322



Item No:5042



Item No:5045



Item No:5102



Item No:5107



Item No:5110



Item No:5051



Item No:5043



Item No:5011



Item No:5104



Item No:5108



Item No:5511



Item No:5052



Item No:5505



Item No:5012



Item No:5105



Item No:5109



Item No:5560



**Item No:5201**



**Item No:5202**



**Item No:5203**



**Item No:5206**



**Item No:5301**



**Item No:5302**



**Item No:5304**



**Item No:5305**



**Item No:5306**



**Item No:5205**



**Item No:5303**



**Item No:5307**



**Item No:5515**



**Item No:5506**



**Item No:5531**



**Item No:5516**



**Item No:5507**



**Item No:5532**



Item No:5501



Item No:5508



Item No:5512



Item No:5502



Item No:5509



Item No:5513



Item No:5503



Item No:5510



Item No:5517



Item No:5504



Item No:5519



Item No:5518



- ◆ Executive Standard EN1254-4 and meet relevant requirements specified in EN1254-1,EN1254-2,EN1254-3, EN1254-5
- ◆ Thread standard ISO228-1
- ◆ Brass Material CW617N in accordance with EN12164
- ◆ Other special alloy required by Customers

- ◆ Working Pressure 1.6MPa/16 Bar
- ◆ Working Temperature -10- 120°C
- ◆ Original color or Chrome Plating Finish
- ◆ OEM/ODM are all welcome.
- ◆ Existing Size:1/2"- 2"



Item No:7100



Item No:7101



Item No:7102



Item No:7103



Item No:7104



Item No:7105



Item No:7106



Item No:7107



Item No:7108



Item No:7109



Item No:7110

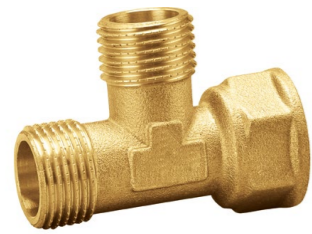

Item No:7111



Item No:7112



Item No:7113



Item No:7114



Item No:7115



Item No:7116

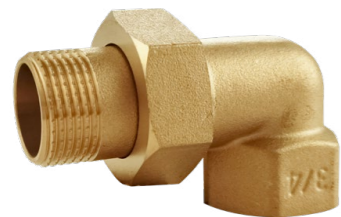

Item No:7117



Item No:7118



Item No:7119

- ◆ For use with PEX-AL-PEX pipe connecting
- ◆ Brass Material CW617N in accordance with EN12164
- ◆ Other special alloy required by Customers
- ◆ Working Pressure 1.6MPa/16 Bar
- ◆ Working Temperature -10- 110°C
- ◆ Original color or Nickel Plating Finish
- ◆ OEM/ODM are all welcome



Item No:7155



Item No:7150



Item No:7153



Item No:7156



Item No:7151



Item No:7154



Item No:7157



Item No:7152



Item No:7162



Item No:7158





- ◆ For use with PEX pipe connecting in European Market
- ◆ Brass Material CW617N in accordance with EN12164
- ◆ Other special alloy required by Customers
- ◆ Working Pressure 1.6MPa/16 Bar
- ◆ Working Temperature -10- 110°C
- ◆ Original color or Nickel Plating finish
- ◆ OEM/ODM are all welcome



**Item No:7205**



**Item No:7200**



**Item No:7201**



**Item No:7202**



**Item No:7203**



**Item No:7204**



**Item No:7205**



**Item No:7206**



**Item No:7207**



**Item No:7208**



**Item No:7209**



**Item No:7210**



**Item No:7211**



**Item No:7220**



**Item No:7222**



**Item No:7225**



**Item No:7224**



**Item No:7221**



**Item No:7223**

## Brass Compression Fittings for PE Pipe

- ◆ For use with PE pipe connecting produced according to DIN8076
- ◆ Extensively used in Europe(expecially Spain)
- ◆ Brass Material CW617N in accordance with EN12164
- ◆ Other special alloy required by Customers
- ◆ Working Pressure 1.6MPa/16 Bar
- ◆ Working Temperature -10- 110°C
- ◆ Original color Finish

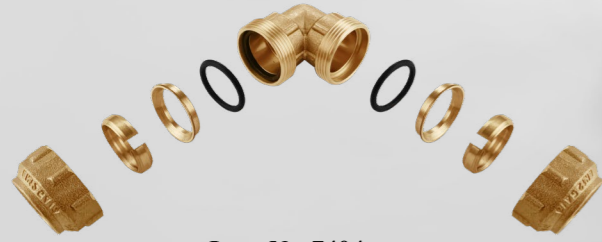

Item No:7404

# Elevate Your Sound, Perfect Your Space.



Now we are planning spread our distribution network further by opening more branches and find more agent in the world to closer to our clients. Welcome everyone who are interested in us.Give us a try! We believe we will stronger together.



Item No:7400



Item No:7401



Item No:7402



Item No:7403



Item No:7404



Item No:7409



Item No:7406



Item No:7407



Item No:7408